

描述 / Descriptions

TO-3P 塑封封装 PNP 半导体三极管。Silicon PNP transistor in a TO-3P Plastic Package.

特征 / Features

用于 60W 音频功率输出，与 2SD1047 互补。

For 60W audio frequency amplifier output stage, Complementary to 2SD1047.

用途 / Applications

用于音频放大电路。

Designed for use in audio frequency amplifier.

内部等效电路 / Equivalent Circuit

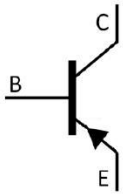

引脚排列 / Pinning

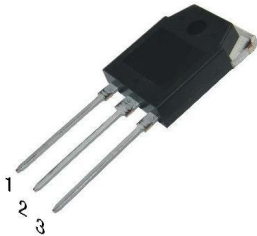

PIN1 : Base PIN 2 : Collector PIN 3 : Emitter

放大及印章代码 / h_{FE} Classifications & Marking

h_{FE} Range	80~160
----------------	--------

极限参数 / Absolute Maximum Ratings(Ta=25°C)

参数 Parameter	符号 Symbol	数值 Rating	单位 Unit
Collector to Base Voltage	V_{CBO}	-160	V
Collector to Emitter Voltage	V_{CEO}	-130	V
Emitter to Base Voltage	V_{EBO}	-6	V
Collector Current - Continuous	I_C	-12	A
Base Current	I_{CP}	-15	A
Collector Power Dissipation	$P_C(T_C=25^\circ C)$	100	W
Junction Temperature	T_j	150	°C
Storage Temperature Range	T_{stg}	-40~150	°C

电性能参数 / Electrical Characteristics(Ta=25°C)

参数 Parameter	符号 Symbol	测试条件 Test Conditions	最小值 Min	典型值 Typ	最大值 Max	单位 Unit
Collector to Emitter Breakdown Voltage	V_{CEO}	$I_C=-50mA$ $I_B=0$	-130			V
Collector Cut-Off Current	I_{CBO}	$V_{CB}=-80V$ $I_E=0$			-0.1	mA
Emitter Cut-Off Current	I_{EBO}	$V_{EB}=-4.0V$ $I_C=0$			-0.1	mA
DC Current Gain	$h_{FE(1)}$	$V_{CE}=-5.0V$ $I_C=-1.0A$	80		160	
	$h_{FE(2)}$	$V_{CE}=-5.0V$ $I_C=-6.0A$	20			
Collector to Emitter Saturation Voltage	$V_{CE(sat)}$	$I_C=-5.0A$ $I_B=-0.5A$	1.1		2.5	V
Base to Emitter Voltage	V_{BE}	$V_{CE}=-5.0V$ $I_C=-1.0A$			1.5	V
Transition Frequency	f_T	$V_{CE}=-5.0V$ $I_C=-1.0A$		15		MHz
Collector Output Capacitance	C_{ob}	$V_{CB}=-10V$ $f=1.0MHz$		300		pF
Turn-On Time	T_{on}	$-10I_{B1}=10I_{B2}=I_C=-1A$		0.25		μs
Full Time	t_f	$-10I_{B1}=10I_{B2}=I_C=-1A$		0.53		μs
Storage Time	t_{stg}	$-10I_{B1}=10I_{B2}=I_C=-1A$		1.61		μs

电参数曲线图 / Electrical Characteristic Curve

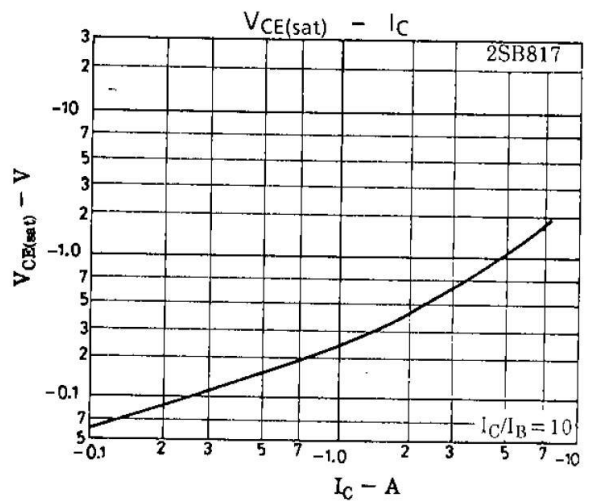
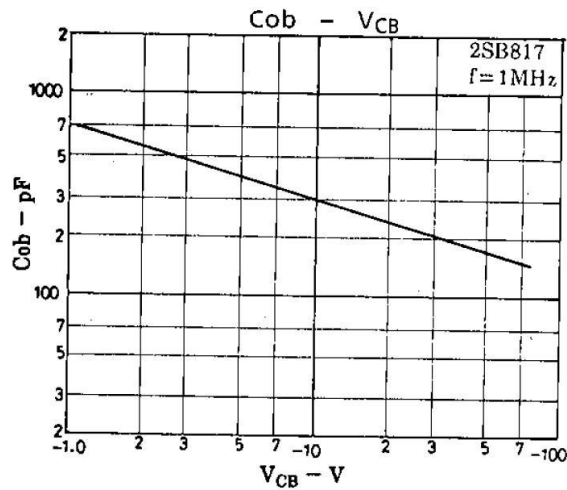
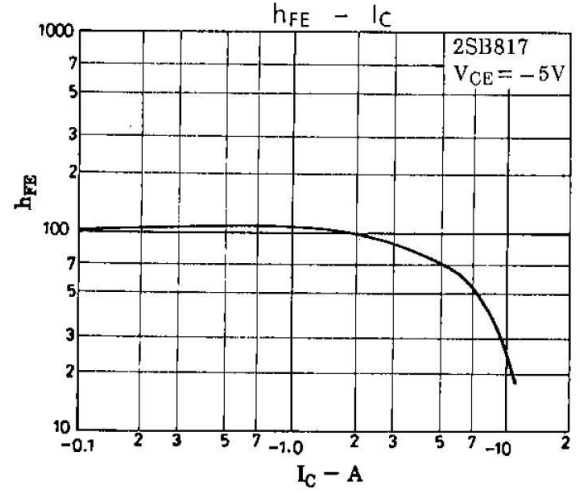
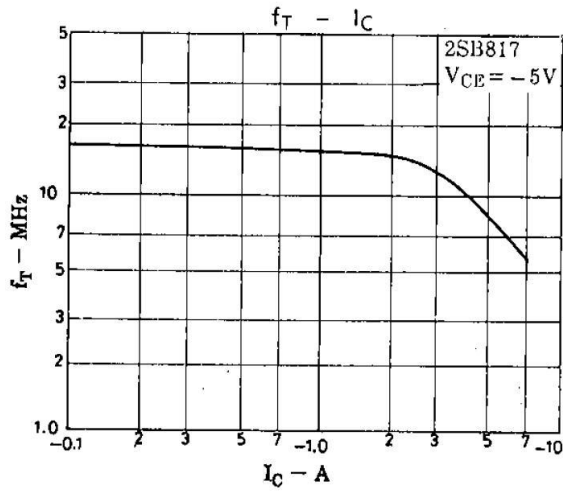
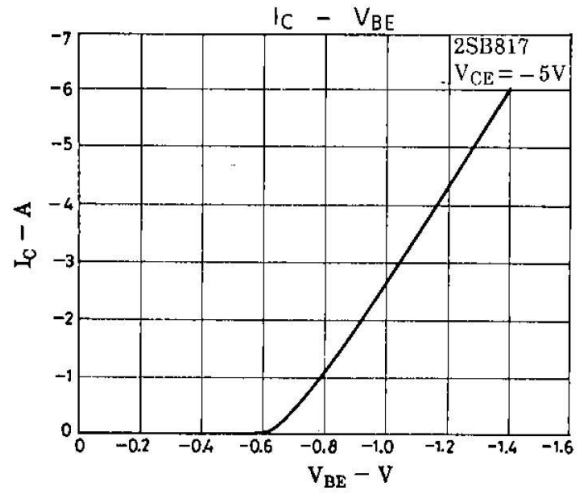
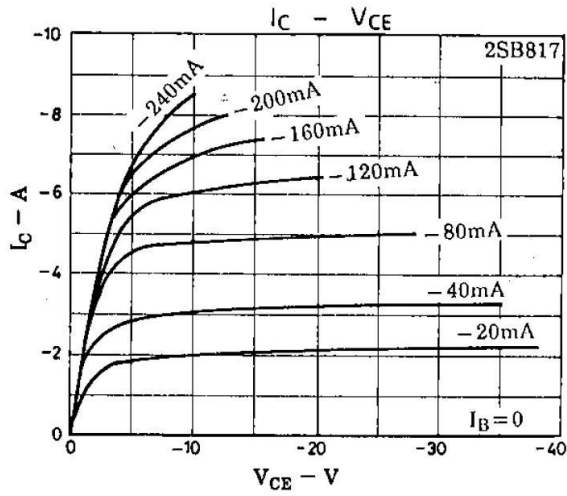

电参数曲线图 / Electrical Characteristic Curve

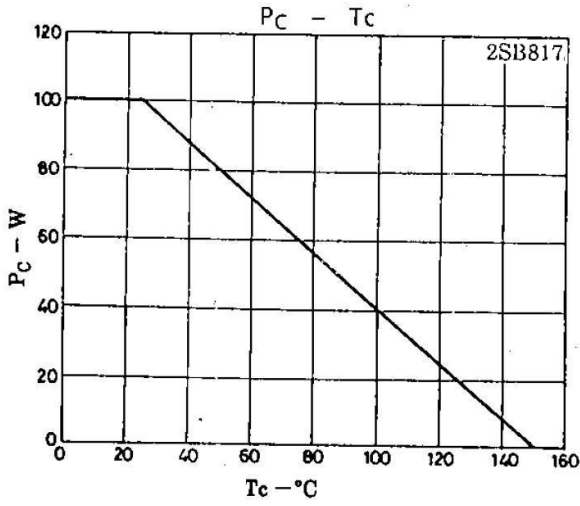
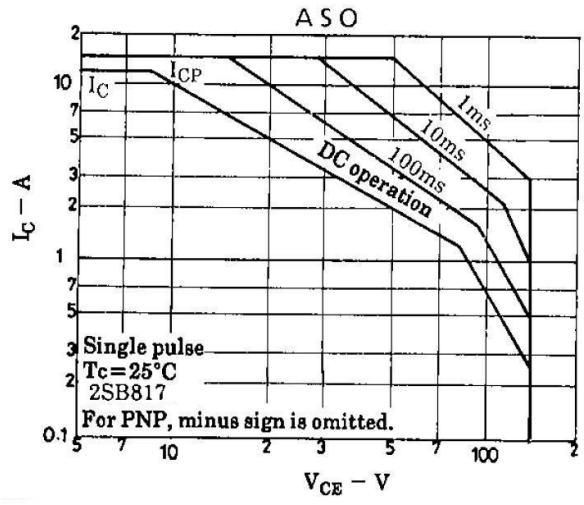
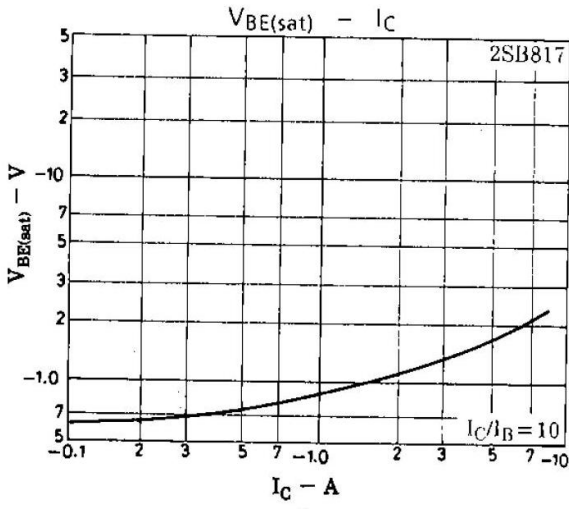

外形尺寸图 / Package Dimensions

TO-3P

单位: mm

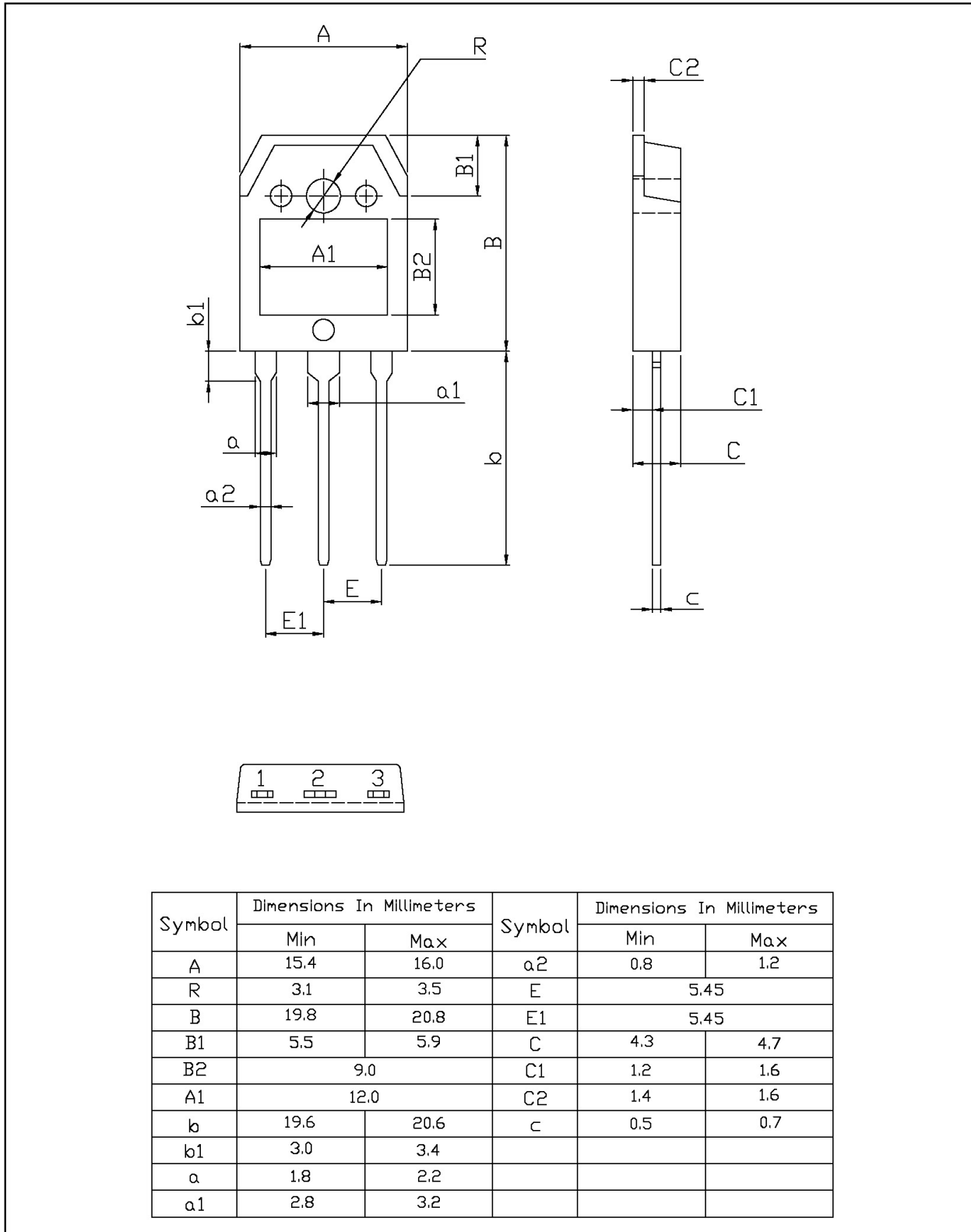

印章说明 / Marking Instructions

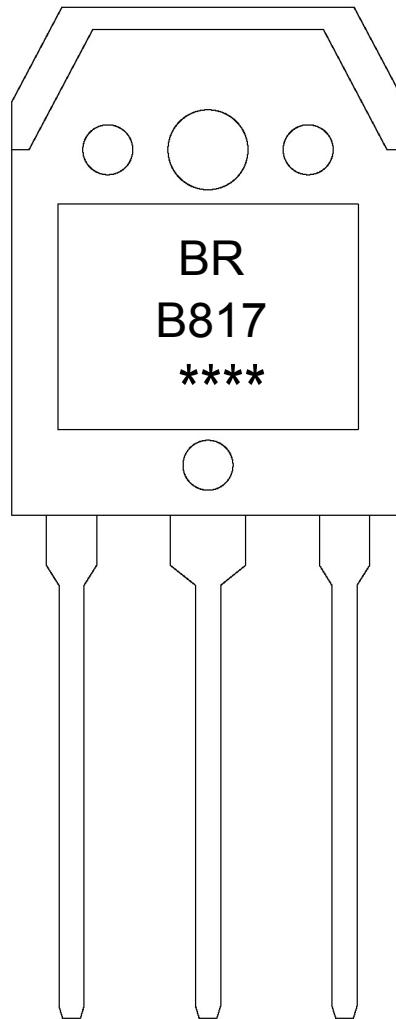

说明：

BR： 为公司代码

B817： 为型号代码

****： 为生产批号代码，随生产批号变化。

Note:

BR: Company Code.

B817: Product Type.

****: Lot No. Code, code change with Lot No.

波峰焊温度曲线图(无铅) / Temperature Profile for Dip Soldering(Pb-Free)

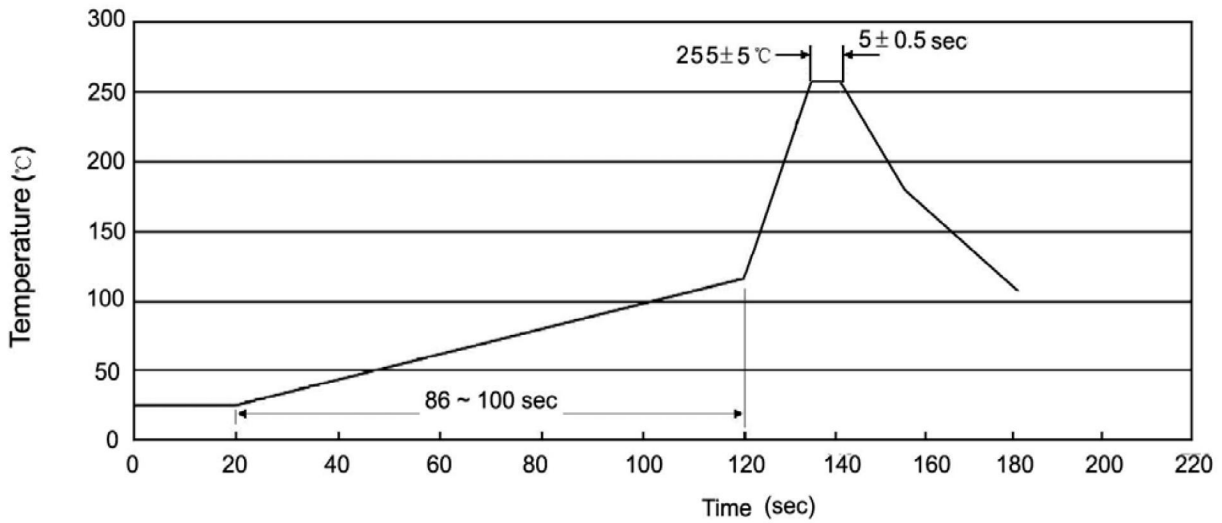

说明：

- 1、预热温度 25~150°C，时间 60~90sec;
- 2、峰值温度 255±5°C，时间持续为 5±0.5sec;
- 3、焊接制程冷却速度为 2~10°C/sec.

Note:

- 1.Preheating:25~150°C, Time:60~90sec.
- 2.Peak Temp.:255±5°C, Duration:5±0.5sec.
3. Cooling Speed: 2~10°C/sec.

耐焊接热试验条件 / Resistance to Soldering Heat Test Conditions

温度：270±5°C 时间：10±1 sec. Temp.:270±5°C Time:10±1 sec

包装规格 / Packaging SPEC.

套管包装 / TUBE

Package Type 封装形式	Units 包装数量					Dimension 包装尺寸 (unit: mm ³)		
	Units/Tube 只/套管	Tubes/Inner Box 套管/盒	Units/Inner Box 只/盒	Inner Boxes/Outer Box 盒/箱	Units/Outer Box 只/箱	Tube 套管	Inner Box 盒	Outer Box 箱
TO-3P	30	15	450	5	2250	497.5×46×8	555×164×50	575×290×180

使用说明 / Notices