

# BC558

Rev.E Mar.-2016

## 描述 / Descriptions

TO-92(R)塑封封装 PNP 半导体三极管。Silicon PNP transistor in a TO-92(R) Plastic Package.

## 特征 / Features

高电压，低噪声。

High Voltage, Low Noise.

## 用途 / Applications

用于一般放大及开关。

General purpose and switching application.

## 内部等效电路 / Equivalent Circuit

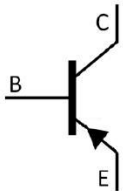

## 引脚排列 / Pinning



PIN1 : Emitter

PIN 2 : Base

PIN 3 : Collector

## 放大及印章代码 / $h_{FE}$ Classifications & Marking

$h_{FE}$ Classifications Symbol	A	B	C
$h_{FE}$ Range	125~250	220~475	420~800

**极限参数 / Absolute Maximum Ratings(Ta=25°C)**

参数 Parameter	符号 Symbol	数值 Rating	单位 Unit
Collector to Base Voltage	$V_{CBO}$	-30	V
Collector to Emitter Voltage	$V_{CEO}$	-30	V
Emitter to Base Voltage	$V_{EBO}$	-5.0	V
Collector Current - Continuous	$I_C$	-100	mA
Emitter Current - Continuous	$I_E$	100	mA
Collector Power Dissipation	$P_C$	625	mW
Junction Temperature	$T_j$	150	°C
Storage Temperature Range	$T_{stg}$	-55~150	°C

**电性能参数 / Electrical Characteristics(Ta=25°C)**

参数 Parameter	符号 Symbol	测试条件 Test Conditions	最小值 Min	典型值 Typ	最大值 Max	单位 Unit
Collector Cut-Off Current	$I_{CBO}$	$V_{CB}=-30V$ $I_E=0$			-0.015	$\mu A$
DC Current Gain	$h_{FE}$	$V_{CE}=-5.0V$ $I_C=-2.0mA$	125		800	
Collector-Emitter Saturation Voltage	$V_{CE(sat)}$	$I_C=-100mA$ $I_B=-5.0mA$			-0.65	V
Base-Emitter Saturation Voltage	$V_{BE(sat)}$	$I_C=-100mA$ $I_B=-5.0mA$		-0.9	-1.1	V
Base-Emitter Voltage	$V_{BE(1)}$	$V_{CE}=-5.0V$ $I_C=-2.0mA$	-0.6		-0.75	V
	$V_{BE(2)}$	$V_{CE}=-5.0V$ $I_C=-10mA$			-0.8	V
Current Gain Bandwidth Product	$f_T$	$V_{CE}=-5.0V$ $I_C=-10mA$ $f=100MHz$		150		MHz
Transition Frequency	$C_{ob}$	$V_{CB}=-10V$ $f=1.0MHz$		4.5		pF
Noise Figure	NF	$V_{CE}=-6.0V$ $I_C=-0.1mA$ $R_g=10K\Omega$ $f=1.0KHz$		1.0	10	dB

电参数曲线图 / Electrical Characteristic Curve

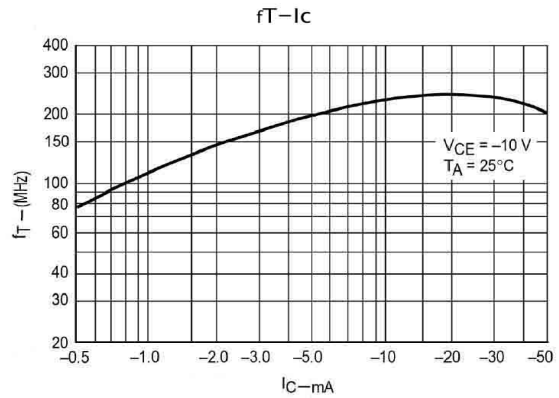
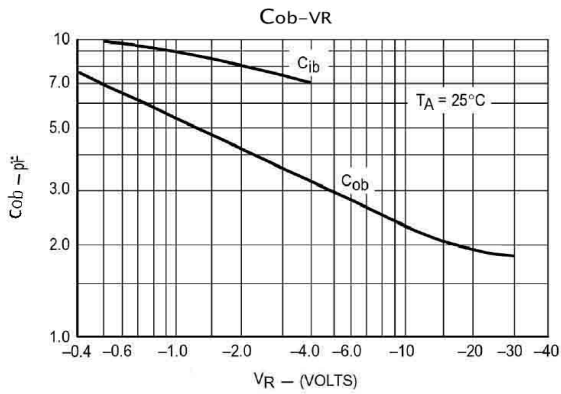
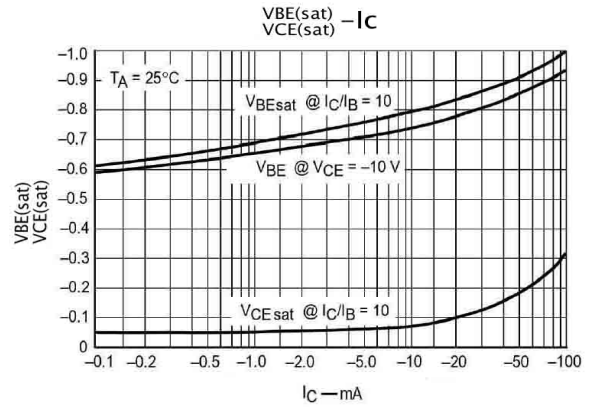
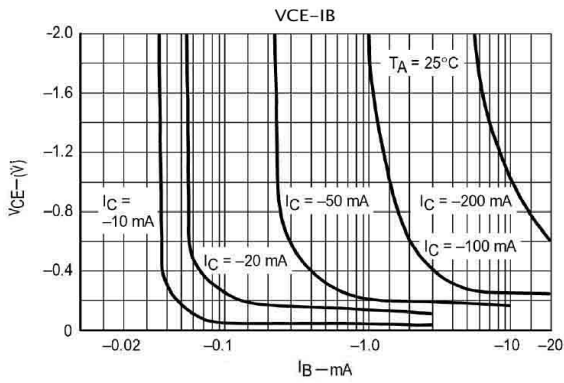
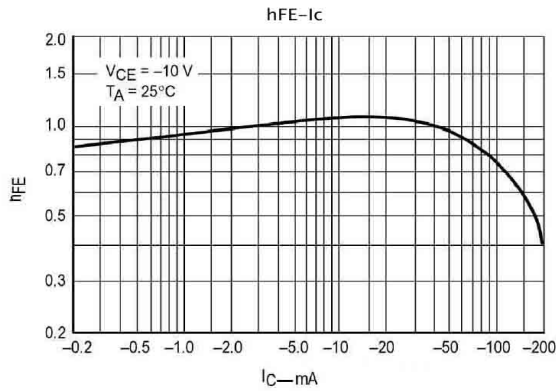

外形尺寸图 / Package Dimensions

TO-92(R)

Unit: mm

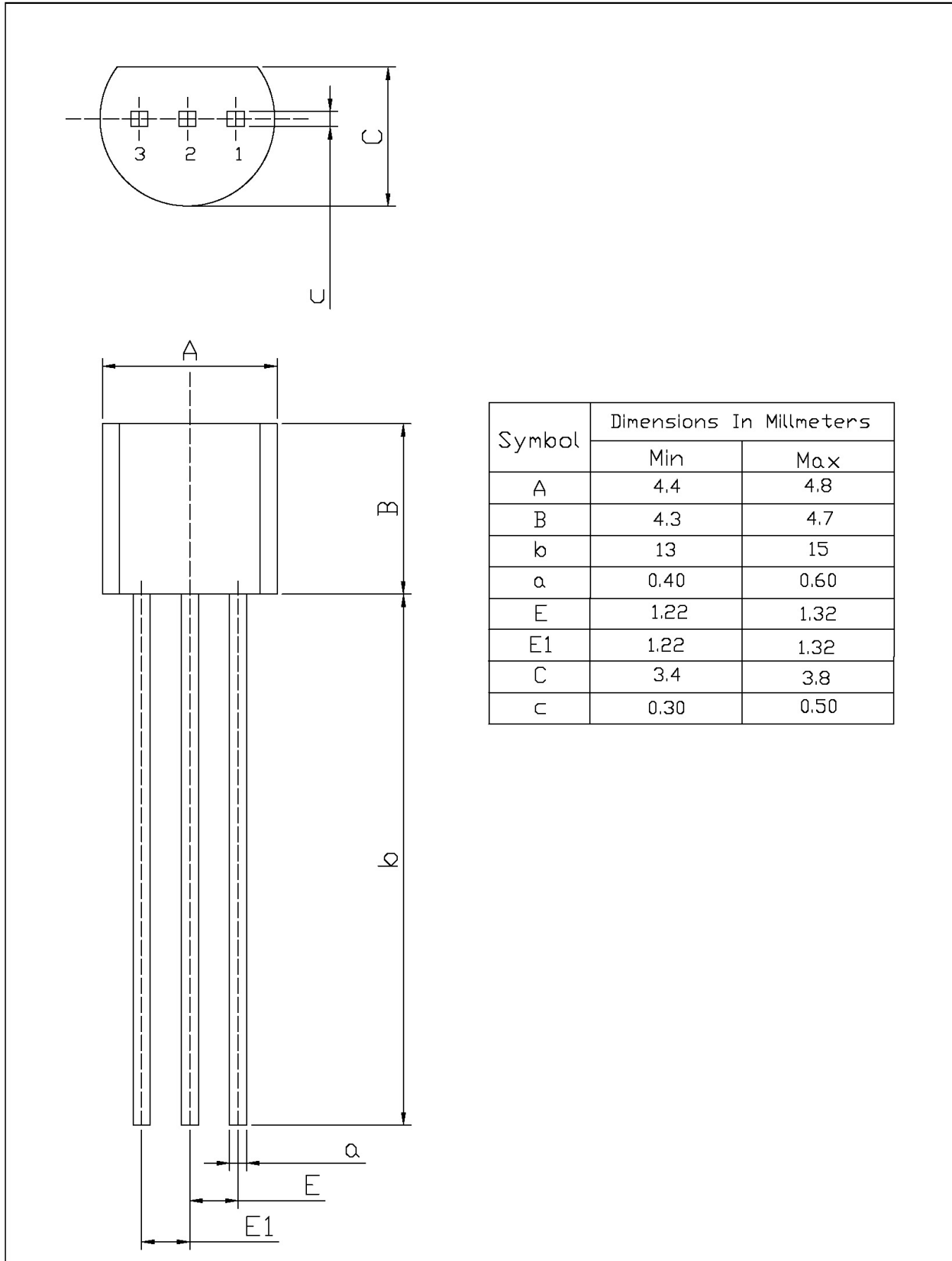

印章说明 / Marking Instructions

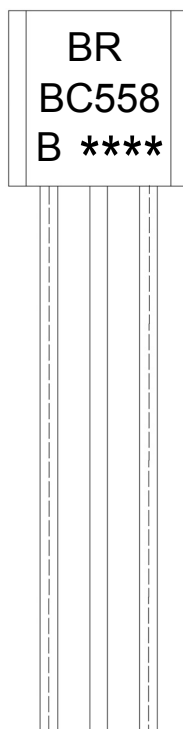

说明：

BR： 为公司代码

BC558： 为产品型号

B： 为  $h_{FE}$  分档代码

\*\*\*\*： 为生产批号代码，随生产批号变化。

Note:

BR: Company Code.

BC558: Product Type.

B:  $h_{FE}$  Classifications Symbol

\*\*\*\*: Lot No. Code, code change with Lot No.

**波峰焊温度曲线图(无铅) / Temperature Profile for Dip Soldering(Pb-Free)**



说明：

- 1、预热温度 25 ~ 150°C，时间 60 ~ 90sec;
- 2、峰值温度 255±5°C，时间持续为 5±0.5sec;
- 3、焊接制程冷却速度为 2 ~ 10°C/sec.

Note:

- 1.Preheating:25~150°C, Time:60~90sec.
- 2.Peak Temp.:255±5°C, Duration:5±0.5sec.
3. Cooling Speed: 2~10°C/sec.

**耐焊接热试验条件 / Resistance to Soldering Heat Test Conditions**

温度：270±5°C

时间：10±1 sec.

Temp.:270±5°C

Time:10±1 sec

**包装规格 / Packaging SPEC.**

散件包装 / BULK

Package Type 封装形式	Units 包装数量					Dimension 包装尺寸 (unit: mm3)		
	Units/Bag 只/袋	Bags/Inner Box 袋/盒	Units/Inner Box 只/盒	Inner Boxes/Outer Box 盒/箱	Units/Outer Box 只/箱	Bag 袋	Inner Box 盒	Outer Box 箱
TO-92	1,000	10	10,000	5	50,000	135×190	237×172×102	560×245×195
	1,000	10	10,000	10	100,000	135×190	237×172×102	560×245×375

编带包装 / AMMO

Package Type 封装形式	Units 包装数量					Dimension 包装尺寸 (unit: mm3)	
	Units/tape 只/纸带	Tape/Inner Box 纸带/盒	Rows/Inner Box 纸带层/盒	Inner Boxes/Outer Box 盒/箱	Units/Outer Box 只/箱	Inner Box 盒	Outer Box 箱
TO-92	3,000	1	120	10	30,000	328×230×42	小箱 480×346×235, 大箱 547×407×268

**使用说明 / Notices**