

描述 / Descriptions

PDFN5×6 封装 N 沟道场效应管。

N-Channel MOSFET in a PDFN5×6 Plastic Package.

特征 / Features

低电阻可最大地降低导电损耗；低栅极电荷，可实现快速切换；低热阻；无卤产品。

Low $R_{DS(ON)}$ to minimize conductive loss; low Gate Charge for fast switching; Low Thermal resistance; HF Product.

用途 / Applications

适用于用户、电信、工业电源和 LED 背光的升压转换器和同步整流器。

For boost converters and synchronous rectifiers for consumer, telecom, industrial power supplies and LED backlighting.

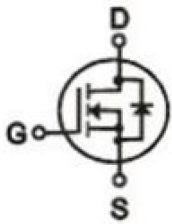
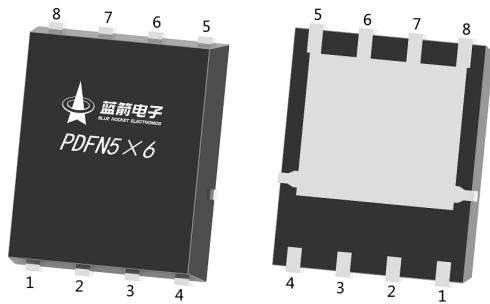
内部等效电路 / Equivalent Circuit**引脚排列 / Pinning**

PIN1、2、3: S

PIN4: G

PIN5、6、7、8: D

Pin	极性
1	S
2	S
3	S
4	G
5	D
6	D
7	D
8	D

印章代码 / Marking

见印章说明。

See Marking Instructions.

极限参数 / Absolute Maximum Ratings($T_a=25^\circ\text{C}$)

参数 Parameter	符号 Symbol	数值 Rating	单位 Unit	
Drain-Source Voltage	V_{DS}	100	V	
Drain Current - Continuous	I_D	90	A	
Drain Current – Pulsed	I_{DM}	200	A	
Gate-Source Voltage	V_{GS}	± 20	V	
Power Dissipation	$P_D(T_c=25^\circ\text{C})$	113.5	W	
Single Pulse Avalanche Energy(L=0.5mH)	E_{AS}	60	mJ	
Avalanche Current(L=0.5mH)	I_{AS}	16	A	
Junction and Storage Temperature Range	T_j, T_{stg}	-55 to 150	$^\circ\text{C}$	
Thermal resistance, junction - ambient	$t \leq 10\text{s}$	$R_{\theta JA}$	20	$^\circ\text{C/W}$
	Steady-State		50	
Thermal resistance, junction - case	Steady-State	$R_{\theta JC}$	1.1	

电性能参数 / Electrical Characteristics($T_a=25^\circ\text{C}$)

参数 Parameter	符号 Symbol	测试条件 Test Conditions	最小值 Min	典型值 Typ	最大值 Max	单位 Unit
Drain-Source Breakdown Voltage	BV_{DSS}	$I_D=250\mu\text{A}, V_{GS}=0\text{V}$	100	111		V
Zero Gate Voltage Drain Current	I_{DSS}	$V_{DS}=100\text{V}, V_{GS}=0\text{V}$			1.0	μA
Gate-Body leakage current	I_{GSS}	$V_{DS}=0\text{V}, V_{GS}=\pm 20\text{V}$			± 100	nA
Gate Threshold Voltage	$V_{GS(th)}$	$V_{DS}=V_{GS}, I_D=250\mu\text{A}$	1	2	3	V
Static Drain-Source On-Resistance	$R_{DS(ON)}$	$V_{GS}=10\text{V}, I_D=20\text{A}$		5.9	7	$\text{m}\Omega$
Static Drain-Source On-Resistance	$R_{DS(ON)}$	$V_{GS}=4.5\text{V}, I_D=10\text{A}$		8.3	10	$\text{m}\Omega$
Input Capacitance	C_{iss}	$V_{DS}=25\text{V}, V_{GS}=0\text{V}$ $f=1.0\text{MHz}$		2700		pF
Output Capacitance	C_{oss}			1000		
Reverse Transfer Capacitance	C_{rss}			70		
Gate resistance	R_g	$V_{GS}=0\text{V}, V_{DS}=0\text{V}$ $f=1\text{MHz}$		1.5		Ω
Total Gate Charge	$Q_{g(10V)}$	$V_{GS}=10\text{V}, V_{DS}=50\text{V}$ $I_D=20\text{A}$		65		nC
Total Gate Charge	$Q_{g(4.5V)}$			31		
Gate Source Charge	Q_{gs}			11		
Gate Drain Charge	Q_{gd}			10		

电性能参数 / Electrical Characteristics(Ta=25°C)

参数 Parameter	符号 Symbol	测试条件 Test Conditions	最小值 Min	典型值 Typ	最大值 Max	单位 Unit
Turn-On Delay Time	$t_{D(on)}$	$V_{GS}=10V, V_{DS}=50V,$ $R_L=2.5\Omega, R_{GEN}=3\Omega$		10		ns
Turn-On Rise Time	t_r			6		
Turn-Off Delay Time	$t_{D(off)}$			51		
Turn-Off Fall Time	t_f			9		

电参数曲线图 / Electrical Characteristic Curve

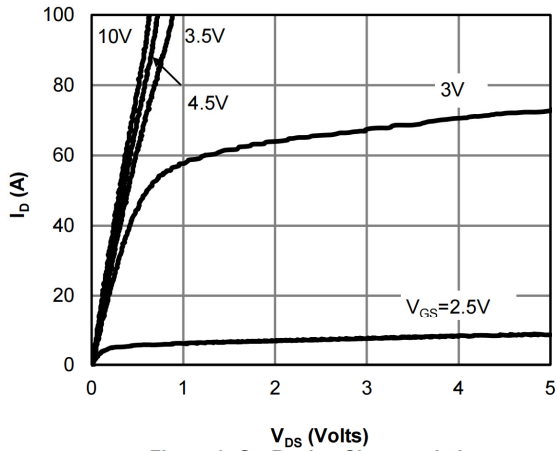

Figure 1: On-Region Characteristics

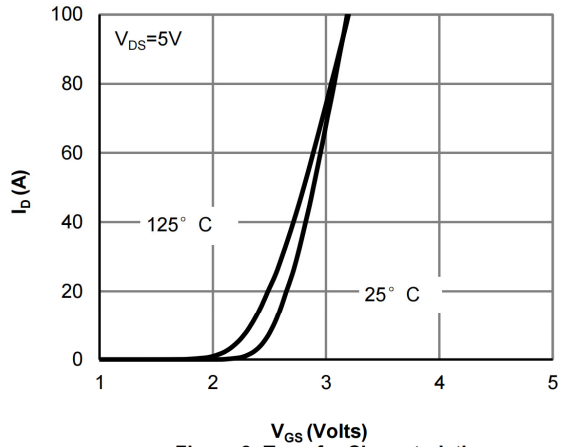

Figure 2: Transfer Characteristics

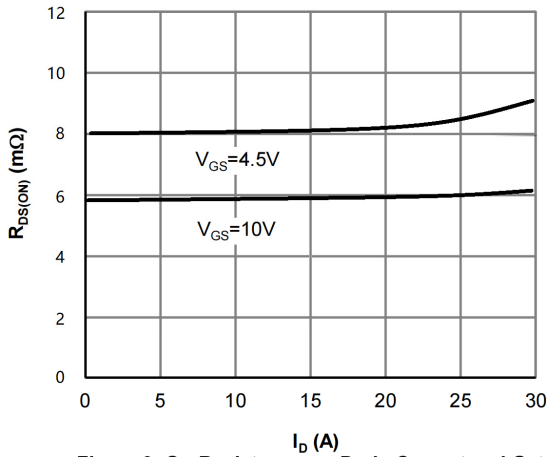

Figure 3: On-Resistance vs. Drain Current and Gate Voltage

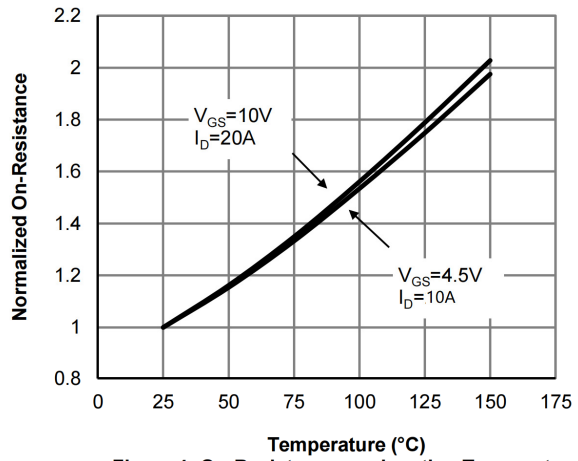

Figure 4: On-Resistance vs. Junction Temperature

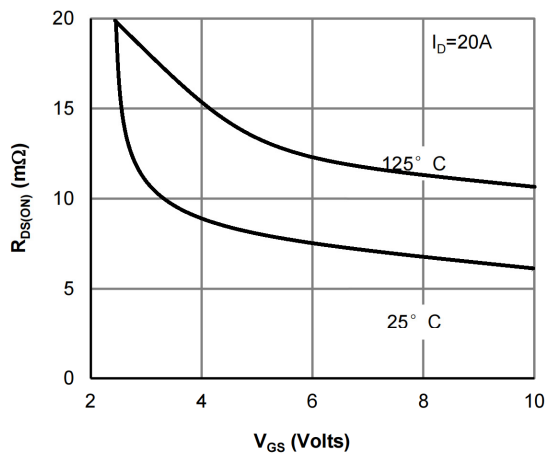

Figure 5: On-Resistance vs. Gate-Source Voltage

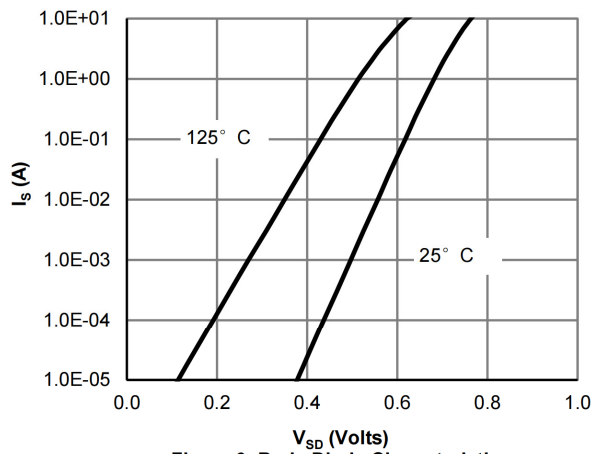

Figure 6: Body-Diode Characteristics

电参数曲线图 / Electrical Characteristic Curve

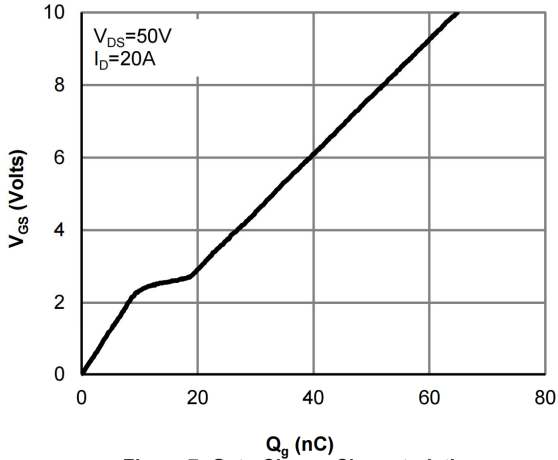

Figure 7: Gate-Charge Characteristics

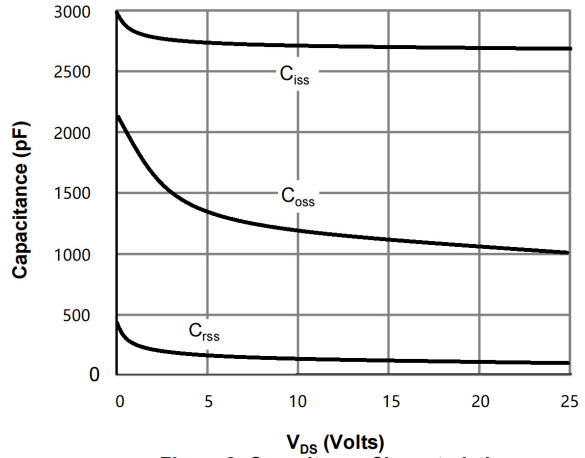

Figure 8: Capacitance Characteristics

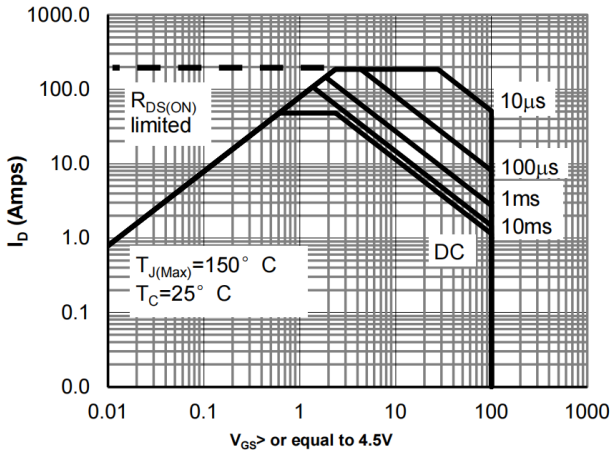

Figure 9: Maximum Forward Biased Safe Operating Area

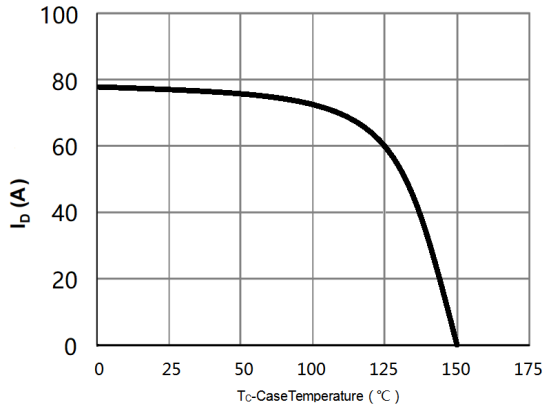

Figure 10: Maximum Continuous Drain Current Vs Case Temperature

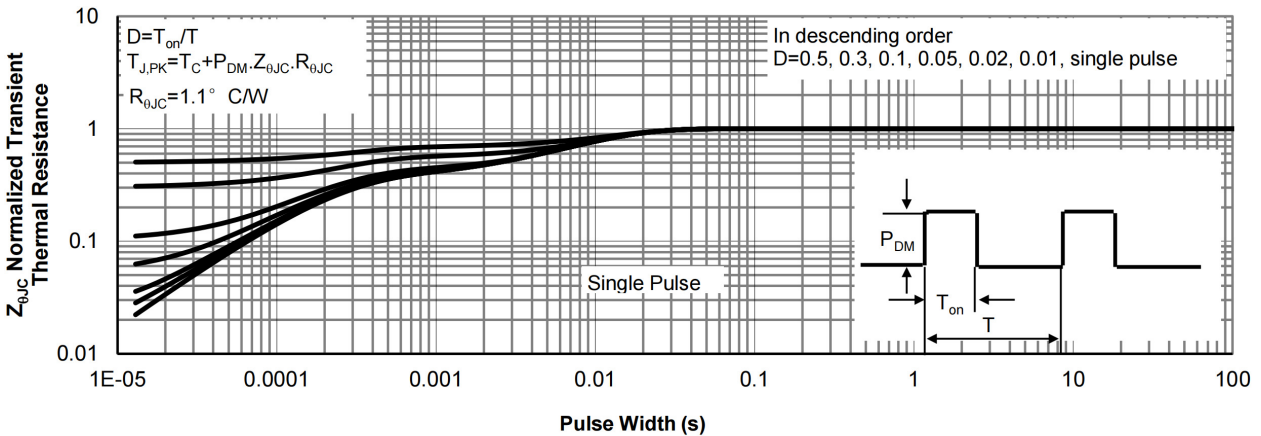

Figure 11: Normalized Maximum Transient Thermal Impedance

BRCS070N10SZC

Rev.B Jan.-2024

外形尺寸图 / Package Dimensions

PDFN5×6

Unit:mm

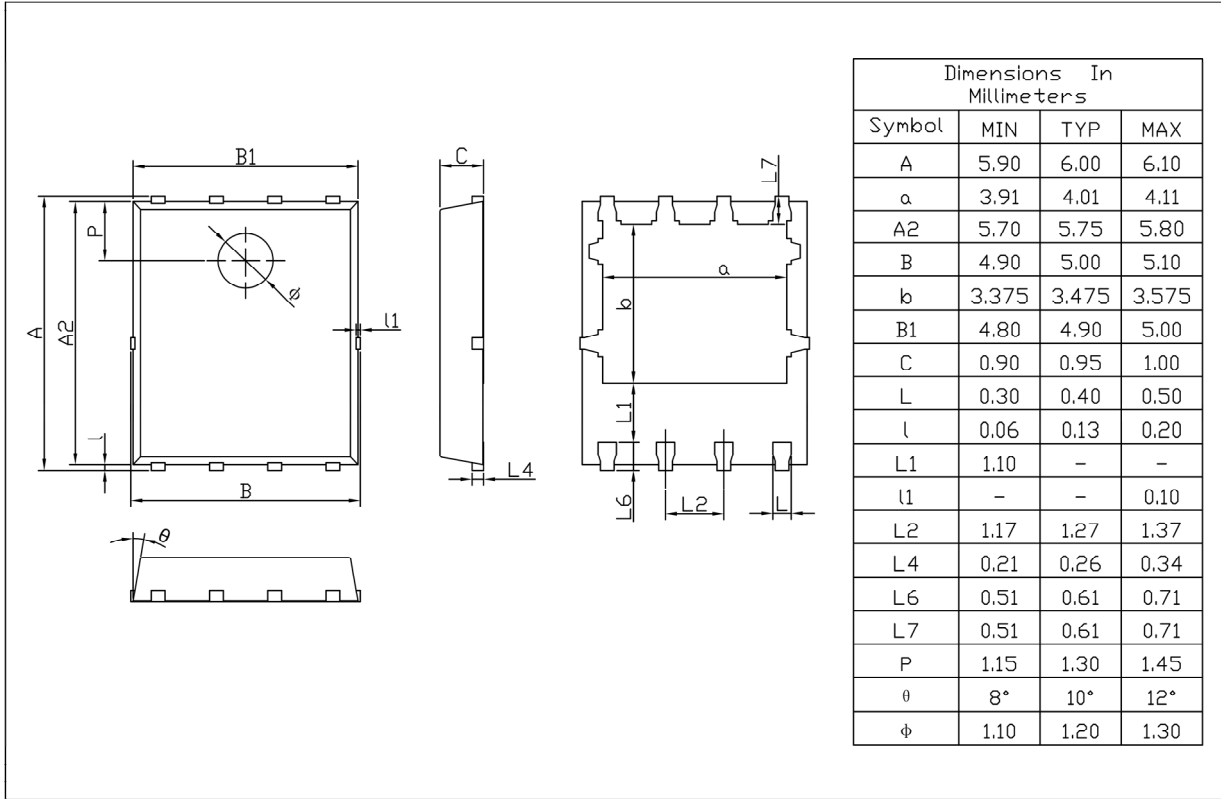

Rev.01 202209

印章说明 / Marking Instructions

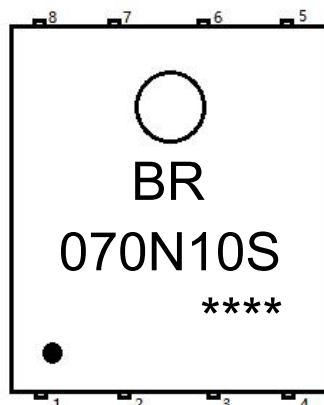

说明：

BR： 为公司代码

070N10S： 为产品型号

****： 为生产批号代码，随生产批号变化

Note：

BR： Company Code

070N10S： Product Type Code

****： Lot No. Code, code change with Lot No

回流焊温度曲线图(无铅) / Temperature Profile for IR Reflow Soldering(Pb-Free)

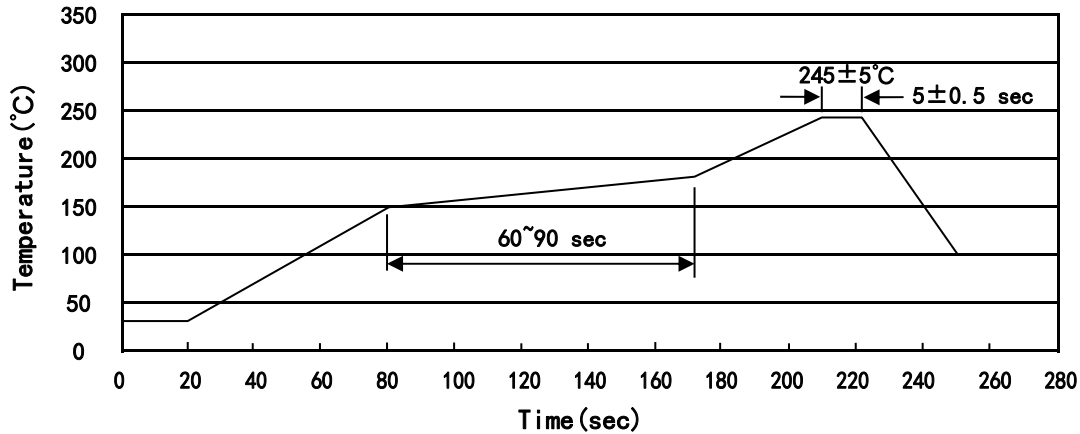

说明：

- 1、预热温度 150~180°C，时间 60~90sec;
- 2、峰值温度 245±5°C，时间持续为 5±0.5sec;
- 3、焊接制程冷却速度为 2~10°C/sec.

Note:

- 1.Preheating:150~180°C, Time:60~90sec.
- 2.Peak Temp.:245±5°C, Duration:5±0.5sec.
3. Cooling Speed: 2~10°C/sec.

耐焊接热试验条件 / Resistance to Soldering Heat Test Conditions

温度：260±5°C

时间：10±1 sec.

Temp.:260±5°C

Time:10±1 sec

包装规格 / Packaging SPEC.

卷盘包装 / REEL

Package Type 封装形式	Units 包装数量					Dimension 包装尺寸 (unit: mm ³)		
	Units/Reel 只/卷盘	Reels/Inner Box 卷盘/盒	Units/Inner Box 只/盒	Inner Boxes/Outer Box 盒/箱	Units/Outer Box 只/箱	Reel	Inner Box 盒	Outer Box 箱
PDFN5×6	5,000	2	10,000	6	60,000	13"×12	360×360×50	380×335×366

使用说明 / Notices