

描述 / Descriptions

SOT-363 塑封封装 NPN+PNP 数字三极管。

Double silicon NPN and PNP transistor in a SOT-363 Plastic Package

特征 / Features

内装偏置电阻，简化线路设计，减少元件和制造流程，无卤产品。

With built-in bias resistors, simplify circuit design, reduce a quantity of parts and manufacturing process, Halogen-free Product.

用途 / Applications

用于开关、界面电路以及驱动电路中。

Switching applications, interface circuit and driver circuit applications.

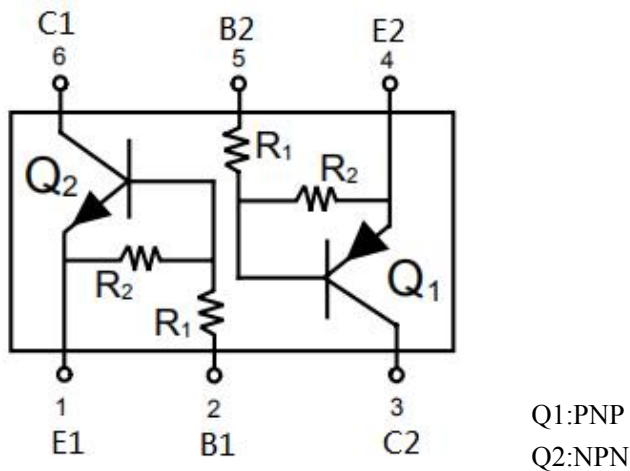
内部等效电路 / Equivalent Circuit**放大及印章代码 / h_{FE} Classifications & Marking**

Marking	H314
---------	------

极限参数 / Absolute Maximum Ratings(NPN,Ta=25°C)

参数 Parameter	符号 Symbol	数值 Rating	单位 Unit
Output Voltage	V_{CC}	50	V
Input Voltage	V_{IN}	40	V
		-6	V
Output Current	I_C	100	mA
	I_O	70	mA
Power Dissipation	P_C	200	mW
Junction Temperature	T_j	150	°C
Storage Temperature Range	T_{stg}	-55~150	°C

电性能参数 / Electrical Characteristics((NPN,Ta=25°C)

参数 Parameter	符号 Symbol	测试条件 Test Conditions	最小值 Min	典型值 Typ	最大值 Max	单位 Unit
Input Voltage(OFF)	$V_{I(off)}$	$v_{CC}=5.0V$ $I_O=100\mu A$			0.3	V
Input Voltage(ON)	$V_{I(on)}$	$V_O=0.3V$ $I_O=1mA$	1.4			V
Output Voltage	$V_{O(on)}$	$I_O=5mA$ $I_I=0.25mA$		0.1	0.3	V
Input Current	I_I	$V_I=5.0V$			0.88	mA
Output Cut-off Current	$I_{O(off)}$	$V_{CC}=50V$ $V_I=0V$			0.5	μA
DC Current Gain	G_I	$V_O=5.0V$ $I_O=5.0mA$	68			
Transition Frequency	f_T	$V_{CE}=10V$ $I_C=5.0mA$ $f=100MHz$		250		MHz
Resistance1	R_1		7	10	13	K Ω
Resistance Ratio	R_2/R_1		3.7	4.7	5.7	

极限参数 / Absolute Maximum Ratings(PNP,Ta=25°C)

参数 Parameter	符号 Symbol	数值 Rating	单位 Unit
Output Voltage	V_{CC}	-50	V
Input Voltage	V_{IN}	-40	V
		6.0	V
Output Current	I_C	-100	mA
	I_O	-70	mA
Power Dissipation	P_C	200	mW
Junction Temperature	T_j	150	°C
Storage Temperature Range	T_{stg}	-55~150	°C

电性能参数 / Electrical Characteristics(PNP,Ta=25°C)

参数 Parameter	符号 Symbol	测试条件 Test Conditions	最小值 Min	典型值 Typ	最大值 Max	单位 Unit
Input Voltage(OFF)	$V_{I(off)}$	$V_{CC}=-5.0V$ $I_O=-100\mu A$			-0.3	V
Input Voltage(ON)	$V_{I(on)}$	$V_O=-0.3V$ $I_O=-1.0mA$	-1.4			V
Output Voltage	$V_{O(on)}$	$I_O=-5.0mA$ $I_I=-0.25mA$		-0.1	-0.3	V
Input Current	I_I	$V_I=-5.0V$			-0.88	mA
Output Cut-off Current	$I_{O(off)}$	$V_{CC}=-50V$ $V_I=0$			-0.5	μA
DC Current Gain	G_1	$V_O=-5.0V$ $I_O=-5.0mA$	68			
Transition Frequency	f_T	$V_{CE}=-10V$ $I_C=-5.0mA$ $f=100MHz$		250		MHz
Resistance1	R_1		7	10	13	K Ω
Resistance Ratio	R_2/R_1		3.7	4.7	5.7	

电参数曲线图 / Electrical Characteristic Curve(NPN)

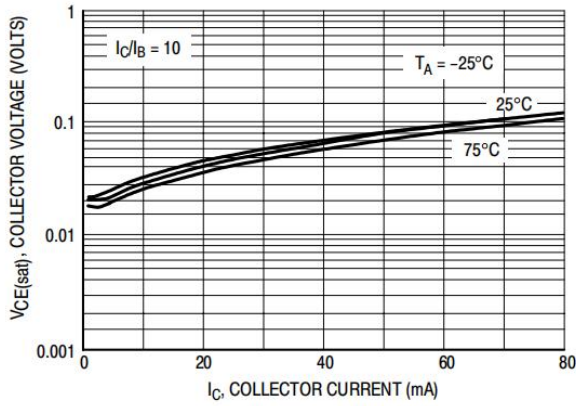

Figure 01. $V_{CE(sat)}$ versus I_C

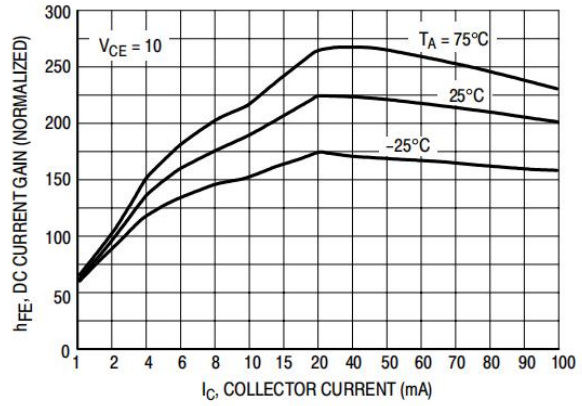

Figure 02. DC Current Gain

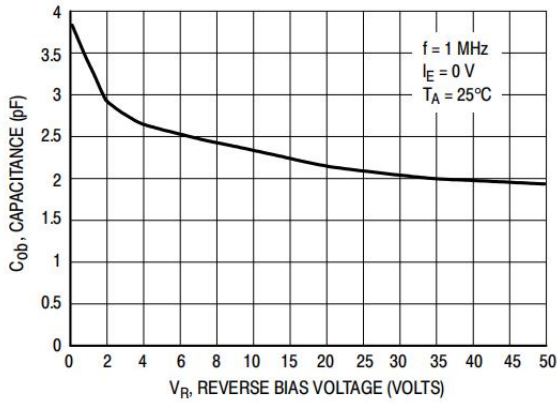

Figure 03. Output Capacitance

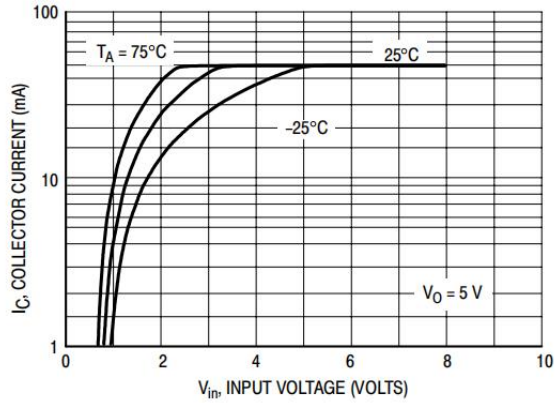

Figure 04. Output Current versus Input Voltage

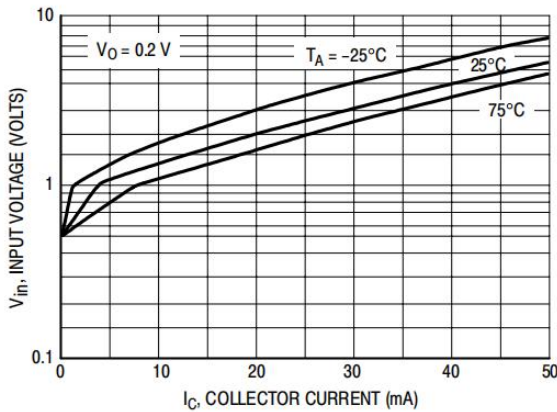

Figure 05. Input Voltage versus Output Current

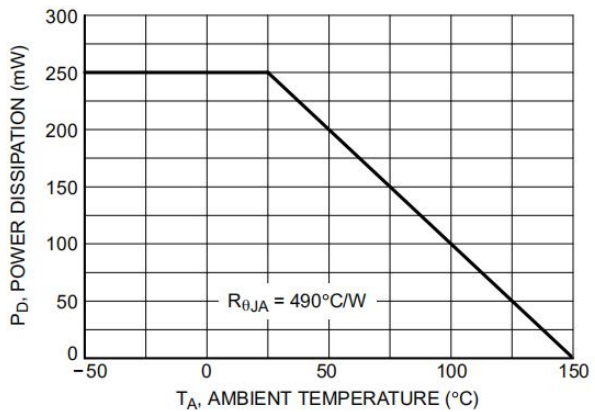

Figure 06. Derating Curve

电参数曲线图 / Electrical Characteristic Curve(PNP)

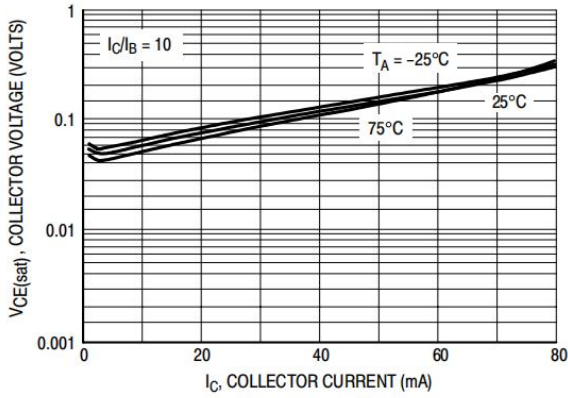

Figure 01. $V_{CE(sat)}$ versus I_C

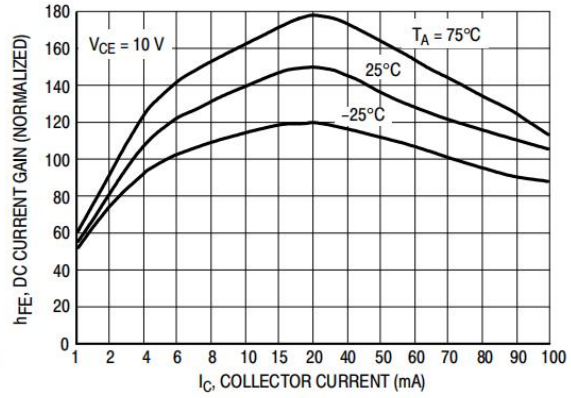

Figure 02. DC Current Gain

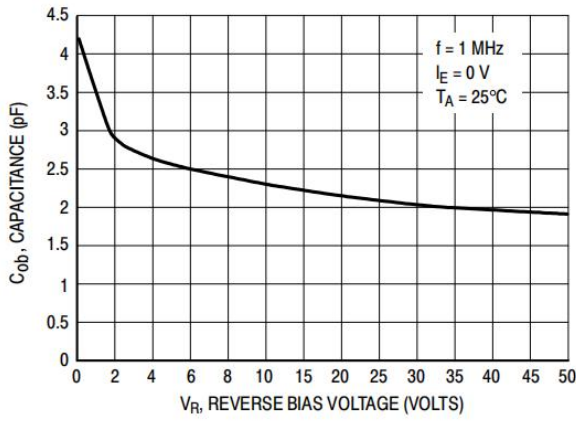

Figure 03. Output Capacitance

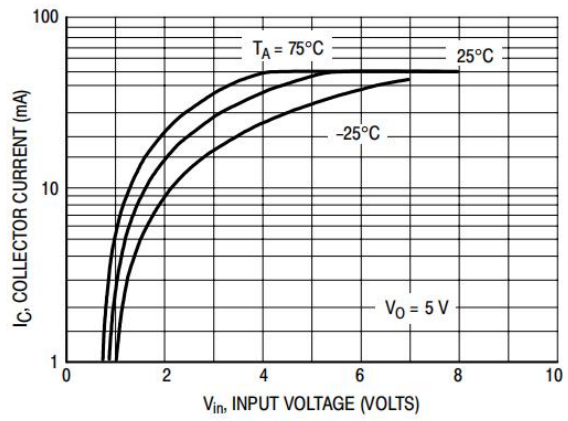

Figure 04. Output Current versus Input Voltage

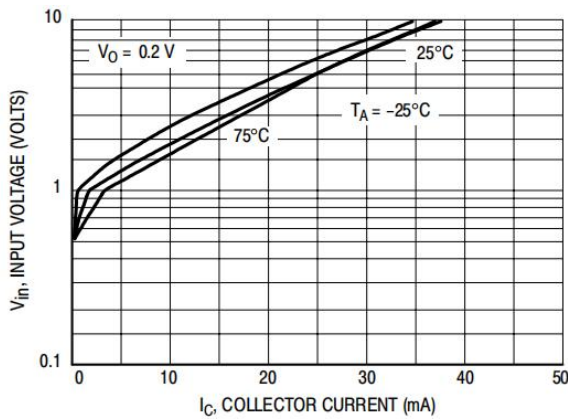

Figure 05. Input Voltage versus Output Current

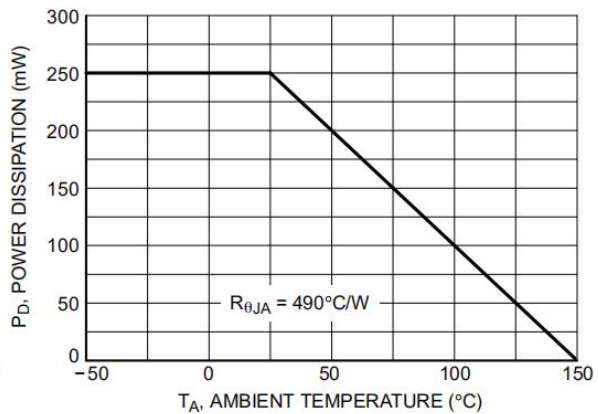
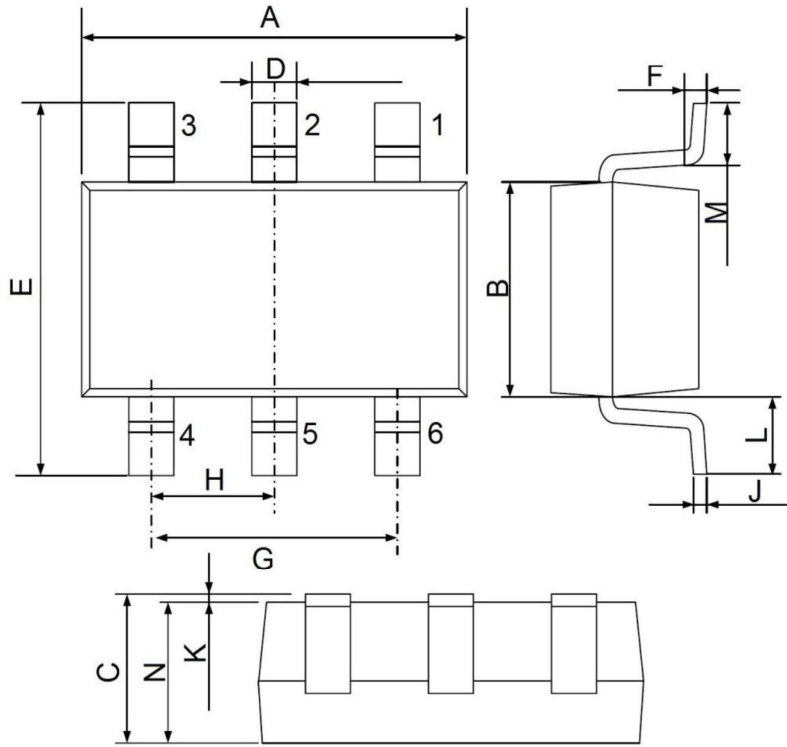

Figure 06. Derating Curve

外形尺寸图 / Package Dimensions

SOT-363-6L



UNIT: mm

DIM	MIN	MAX
A	2.00	2.20
B	1.15	1.35
C	0.90	1.10
D	0.15	0.35
E	1.95	2.25
F	0.20 Typ.	
G	1.20	1.40
H	0.65 Typ.	
J	0.08	0.15
K	0.00	0.10
L	0.525 Ref.	
M	0.26	0.46
N	0.90	1.10

印章说明 / Marking Instructions

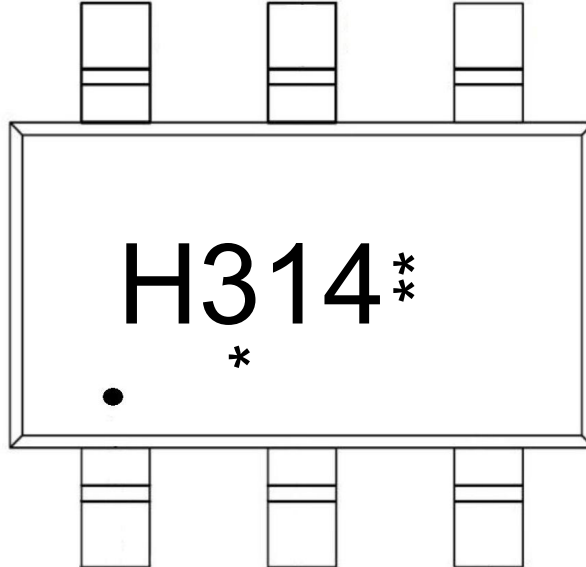

说明：

- ：为“1”脚
- H314：为型号代码
- ***：为生产批号代码，随生产批号变化

Note:

- ：“1” Pin
- H314：Product Type Code
- ***：Lot No. Code, code change with Lot No.

回流焊温度曲线图(无铅) / Temperature Profile for IR Reflow Soldering(Pb-Free)

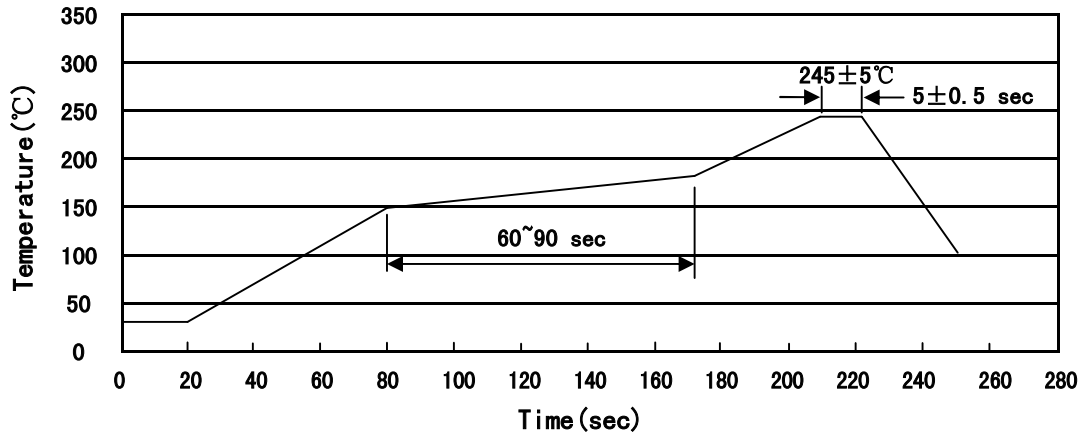

说明：

- 1、预热温度 150~180°C，时间 60~90sec;
- 2、峰值温度 245±5°C，时间持续为 5±0.5sec;
- 3、焊接制程冷却速度为 2~10°C/sec.

Note:

- 1.Preheating:150~180°C, Time:60~90sec.
- 2.Peak Temp.:245±5°C, Duration:5±0.5sec.
3. Cooling Speed: 2~10°C/sec.

耐焊接热试验条件 / Resistance to Soldering Heat Test Conditions

温度：260±5°C

时间：10±1 sec.

Temp.:260±5°C

Time:10±1 sec

包装规格 / Packaging SPEC.

卷盘包装 / REEL

Package Type 封装形式	Units 包装数量					Dimension 包装尺寸 (unit: mm ³)		
	Units/Reel 只/卷盘	Reels/Inner Box 卷盘/盒	Units/Inner Box 只/盒	Inner Boxes/Outer Box 盒/箱	Units/Outer Box 只/箱	Reel	Inner Box 盒	Outer Box 箱
SOT-363	3,000	10	30,000	6	180000	7" ×8	180×120×180	390×385×205

使用说明 / Notices